

CETOL 6σ Tutorial

For Pro/Engineer and Creo Parametric

The table

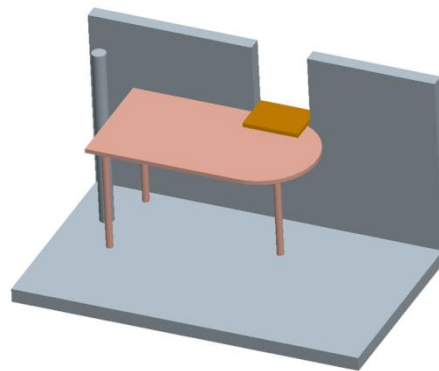

The Table

Description: This tutorial will show you the basic functionality of CETOL 6 Sigma.

An analysis normally starts with a definition of a measure. The measure is used to measure the variation at a certain place in a model. In this tutorial, it will measure a gap, to verify if parts will fit.

The second part of the tutorial is focusing on defining constraints between the parts. (The assembly constraints in ProE is based on perfectly nominal geometry. In CETOL we use constraints called joints, representing the actual physical connections).

Variation will then be defined for the model, by identifying the “functional surfaces” in ProE and use them in CETOL. The functional surfaces will be connected by constraints, and the tolerance based variation added to them.

The last part is focusing on running the analysis, control the sensitivities (geometrical ratios), review the contribution of each tolerance to the total variation, and finally optimize the tolerances.

Objective: The purpose of this tutorial is to learn the basic functionality in CETOL, and how it can be used to optimize performance, robustness and production cost.

Key words: Measures, Joints, Features (CETOL's), Variation, Sensitivities, Contributions, Tolerance optimization

Files: table.asm, table.prt, floor.prt

This assignment is self instructing, step by step.



Notes

Preparations

1. Start Pro/Engineer and find folder “Table”.
2. Open the assembly ”**table.asm**”. Hide all datum geometry.
3. Start up CETOL Modeler, and click  to synchronize it with ProE.

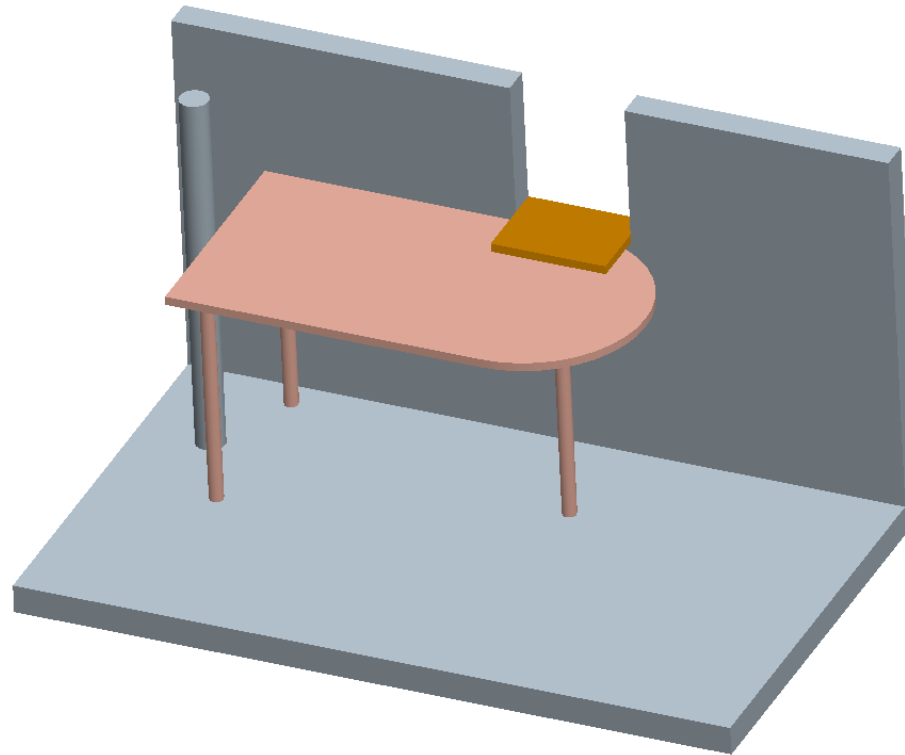



Preparations

- In the top of the CETOL window, choose **Tools** and then **Options**.
Here you can decide the default values for tolerances. (If you know that there is a lot of 0,1 tolerances in your model, you can save some time by setting the default value to 0,1.) The default tolerances are not important for this tutorial.
- Click the button **Edit Rule...**.
Change the metric to “Sigma” and the value to **3**.
(This is the same as a Cpk value of 1 and is a measure of how accurate the manufacturing is.)

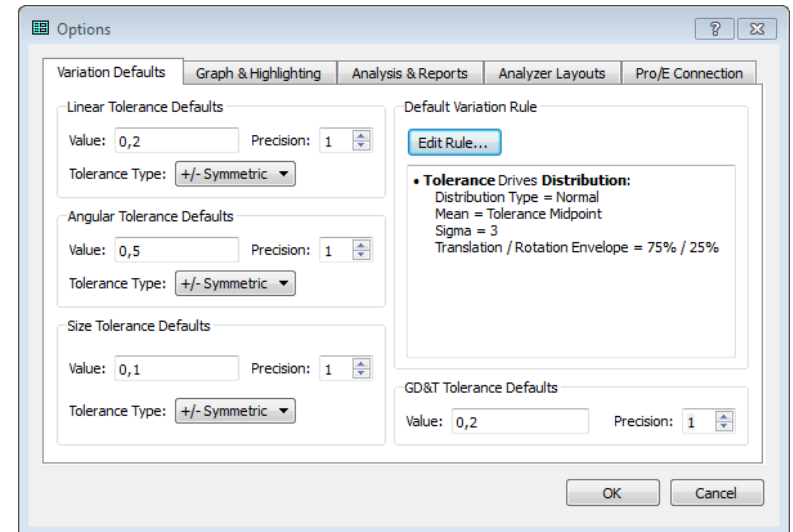
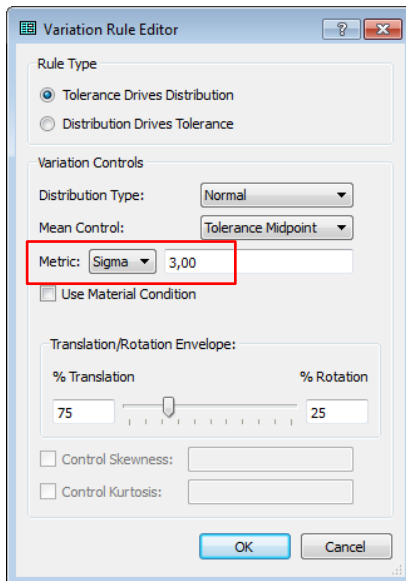



Notes

About Measures

The first thing to think about when analyzing a model in CETOL, is where to analyze the variation. The variation measure is called "Measure" in CETOL, and it is measuring linear or angular variation between features (e.g. surface, line, vertex).

In this assignment, the variation will be measured between the top of the 3-leg table and the shelf mounted at the wall.

The table is supposed to fit under the shelf (Shown in the figure), and the question is if it will do that, considering the variation of the table and the mounting height of the shelf.

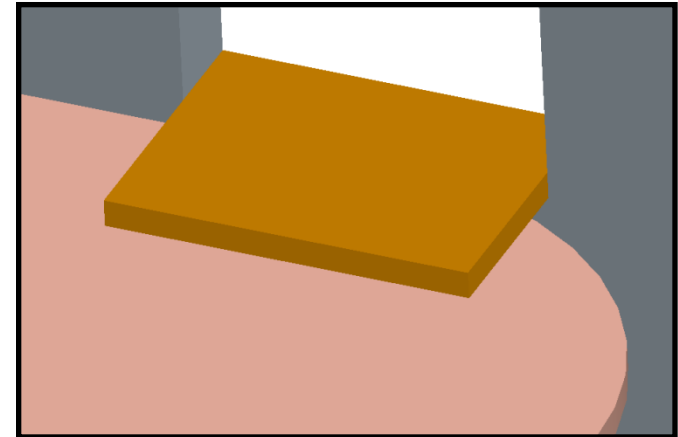
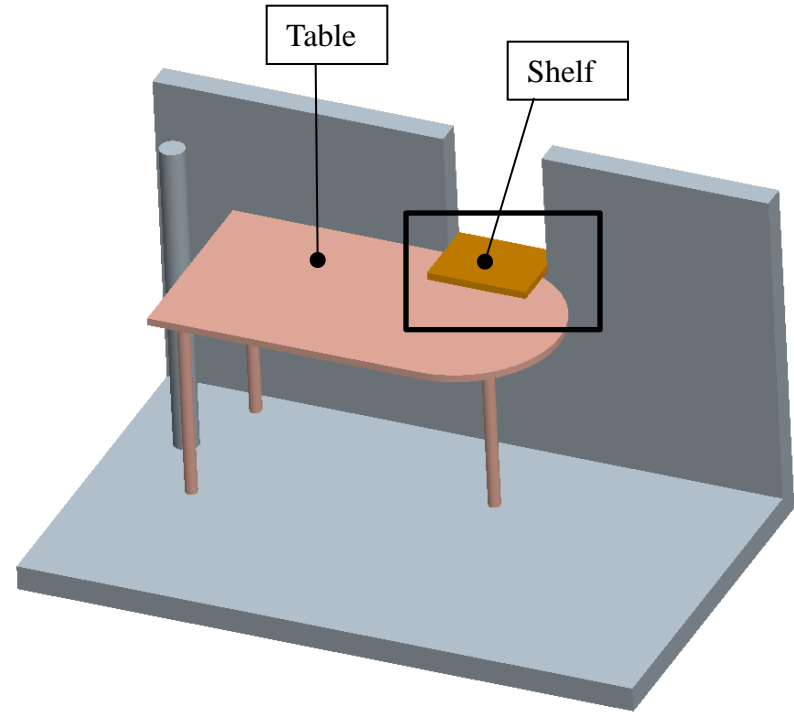



Notes

Define Measures

1. Click on  in ProE and select the view “ISO1”.

2. Define a “Measure“ between the top surface of the table and the lower left corner of the shelf:

Click on  in CETOL to start the Measure definition.

Select the lower left corner of the shelf (Shown at 1 – Use query to select the vertex). Then hold Ctrl while selecting the top surface of the table.

3. The lower figure shows the measure, with the green arrows that shows the measured distance. There is a small nominal gap of 1 mm. (hard to see without zooming in). The features used in the measure are also highlighted.

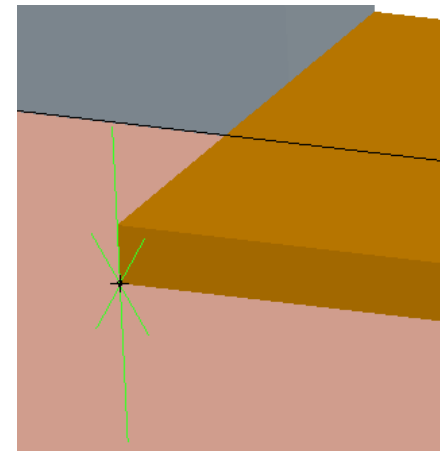
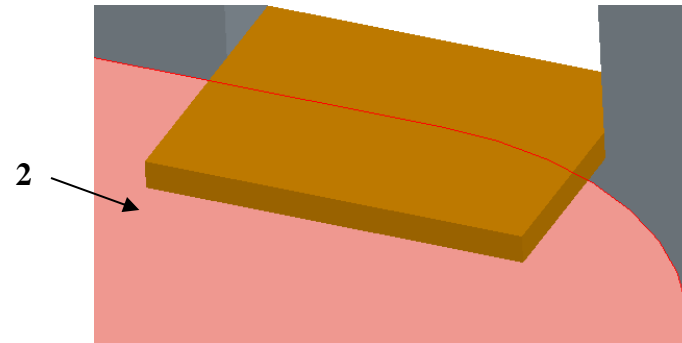
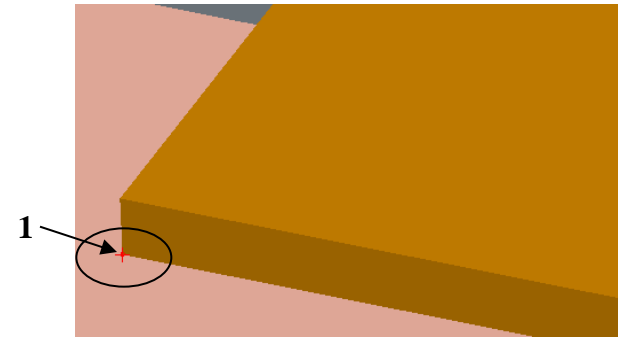



Notes

Define Measures

4. Click on the new Measure (in the Tree view). (If it is not shown at the root level of the tree, click on the triangle next to Config2 to find it.)
5. In the Properties view, click on the General tab and change the name to "Gap Table-Shelf".
6. In the Properties view, click on the Variation tab and change the Type to Limits. Define the upper limits to **5 mm** and the lower to **0 mm**. Set Precision to **1**.

The limits are the requirements you have on the variation of the design. The upper limit is not important in this case, but if we have variation below the lower limit of 0 mm, the table will not fit under the shelf.

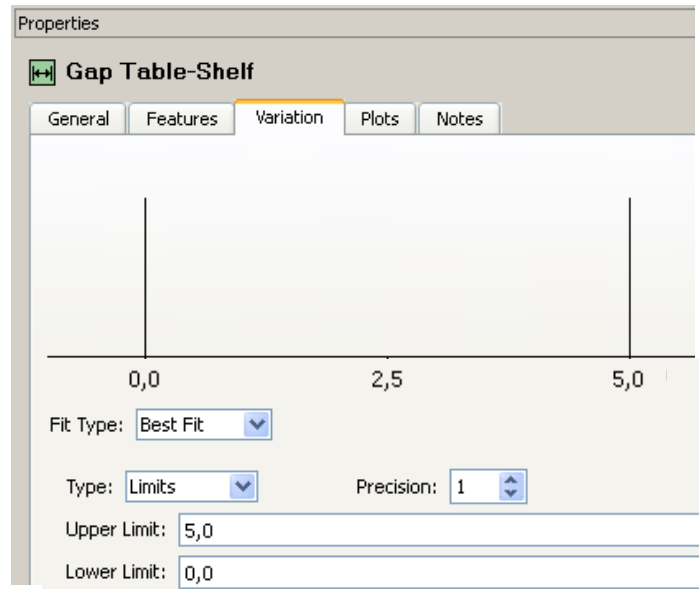
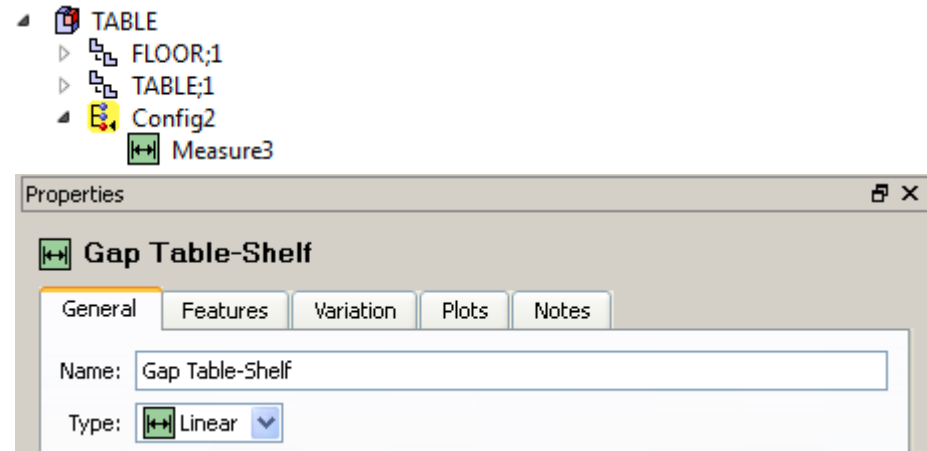



About Joints

Pro/Engineer is only handling perfect nominal geometry, and when assembling parts, no variation is taken into account.

All real designs have variation, and in order to handle that, the parts and the sub-assemblies in the tolerance analysis need to be constrained in a more physically correct way. (The small variation in each part need to propagate in a physically correct way through the design). The constraints used to model this in CETOL is called Joints.

The Joints should be applied in the same order and way as the real design is assembled.

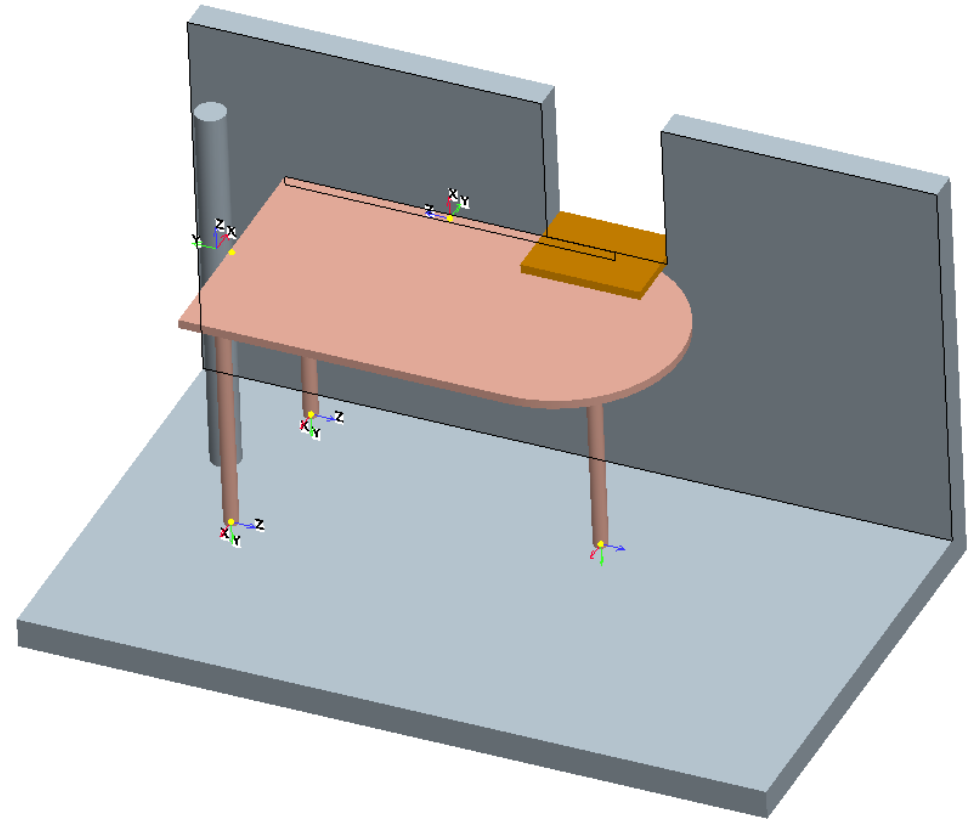





Notes

Define Joints

1. Click on  in ProE and select the view "ISO1".
2. Define Joints between the legs and the floor:

Click on  in CETOL to start the Joint definition.

First select the floor surface. Then hold Ctrl while selecting the highlighted surface of Leg 1.
3. Select the new Joint in the tree  TABLE;1 to FLOOR;1,1
4. In the Properties view and under the General tab, unselect the option "Use Default Name" and change the name of the joint to "Floor - Leg1". (Hit the Enter button if necessary)
5. CETOL suggest a type of Joint based on the surfaces selected, just like ProE does. In ProE this joint would have been a "Mate". The corresponding joint created in Cetol is called "Planar Contact". The constrained DOFs (degrees of freedom) and a symbol for planar contact in shown in the Property view.
6. In the Properties view, change from "Planar Contact" to a "Point Contact" in the drop down menu. The "Point Contact" controls the design in a much more physically correct way. (Considering variation in the parts. E.g. a small variation in length of the table legs.)
7. Repeat 2-6 in order to create two more Joints for the for Leg 2 and 3.

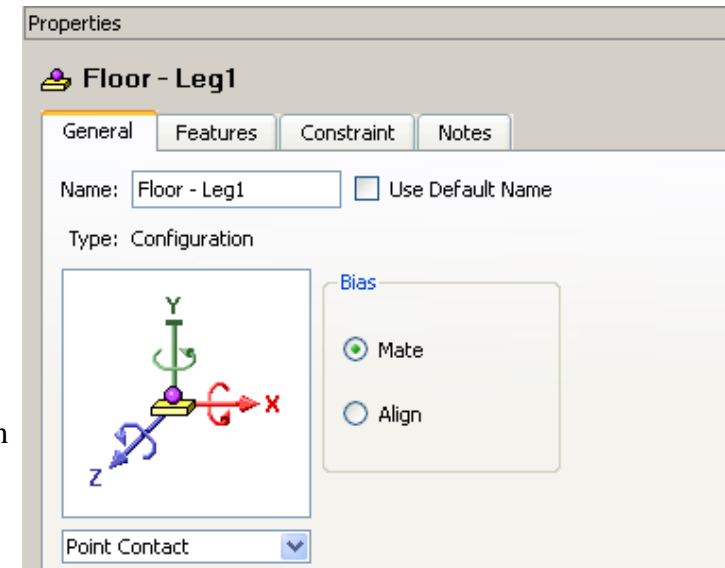
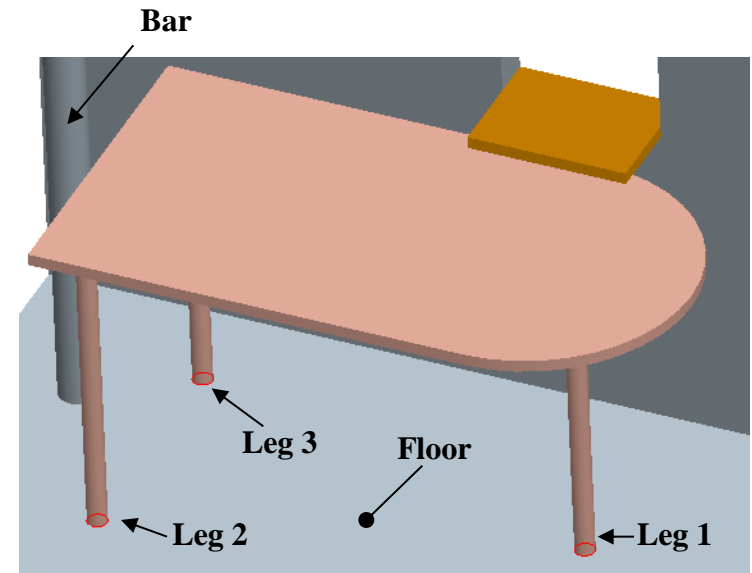





Notes

Define Joints

8. Define a fourth Joint between the table and the bar:

Click on  in CETOL to start the Joint definition.

First select the highlighted surface of the Bar. Then hold Ctrl while selecting the highlighted side surface of the Table.

9. Select the new Joint in the tree.  TABLE;1 to FLOOR;1, 4
10. In the Properties view and under the General tab, unselect the option "Use Default Name" and change the name of the joint to "Bar – Table". (Hit the Enter button if necessary)
11. In the Properties view, change from "Line Contact" to a "Point Contact" in the drop down menu. (The "Point Contact" controls the design in a more physically correct way.)

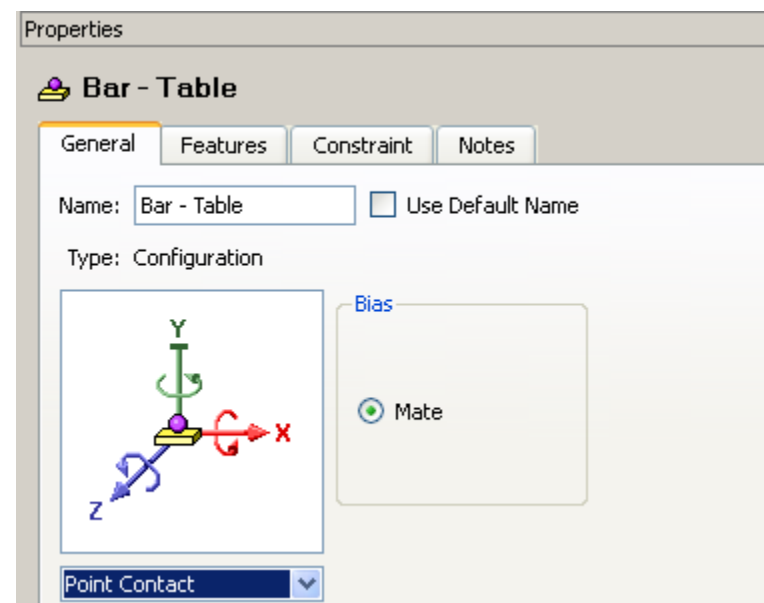
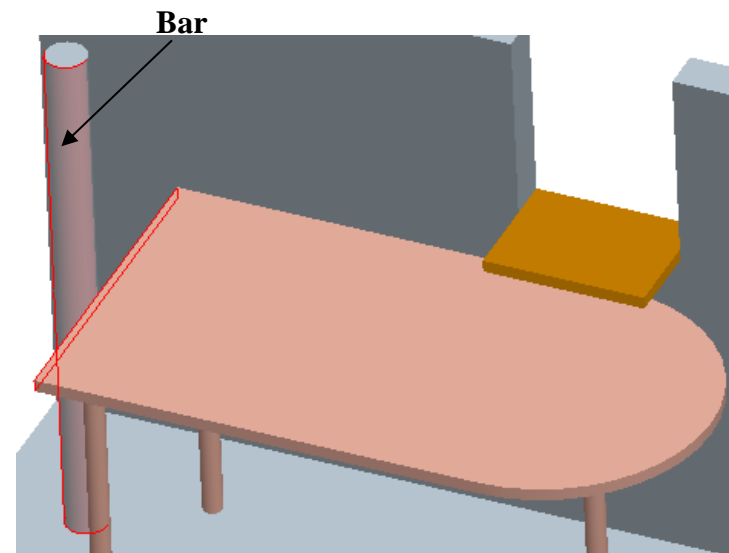





Notes

Define Joints

12. Define a fifth and final Joint between the wall and the table:

Click on  in CETOL to start the Joint definition.

First select the highlighted surface of the wall. Then hold Ctrl while selecting the highlighted side surface of the Table.

13. Select the new Joint in the tree.  TABLE;1 to FLOOR;1, 5

14. In the Properties view and under the General tab, unselect the option "Use Default Name" and change the name of the joint to "Wall – Table". (Hit the Enter button if necessary)

15. In the Properties view, change from "Planar Contact" to a "Line Contact Along Z" in the drop down menu. The "Line Contact Along Z" controls the design in a more physically correct way. Look at the red/green/blue arrows at the joint symbol in ProE and compare it to the red/green/blue arrows in the Properties view. Make sure that you understand which DOFs are controlled. (The DOF directions that ends with an arrow are free, the other ones are constrained)

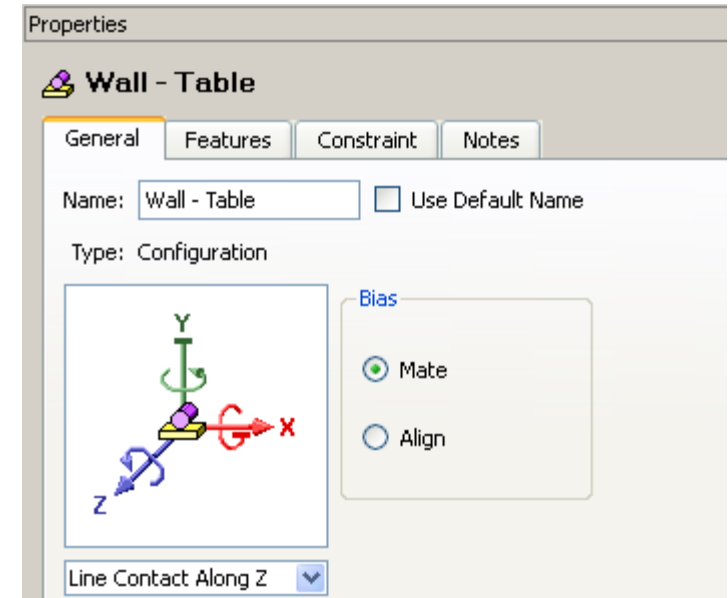
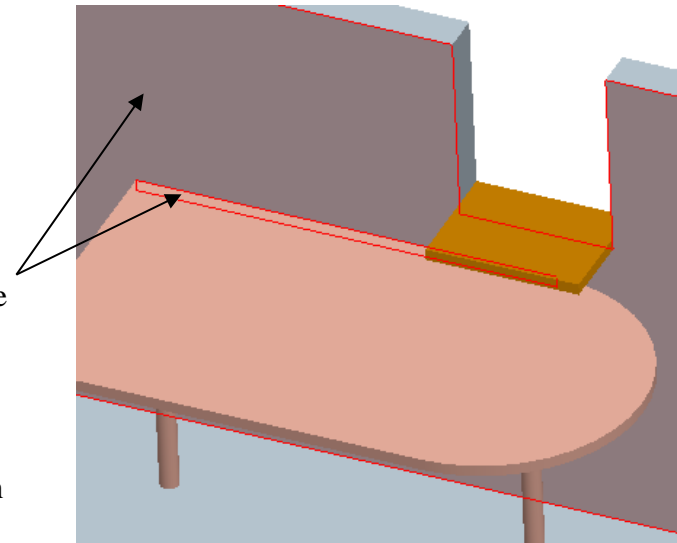



Notes

Define Joints

16. The model graph should now look like the figure to the right.
17. The status of the constraining is shown on the lower right hand side of CETOL. It should now look like this `Over: 0 Under: 0 (Closed)`. This means that the model is perfectly constrained. (I.e. not over- or under-constrained)
18. Have another look at all the joints (click on each one) and make sure you understand how the position of the table is controlled by them. (6 DOFs is controlling the position of the Table, three translational and three rotational. Keep in mind that a pair of translational constraints can control rotational degrees of freedom as well)
19. The position of the table in the CETOL analysis will not be the same as the nominal position in ProE. Click on  (Located at the top bar in CETOL) to verify the analysis position of the Table in CETOL. Notice that the table moves to be in contact with the bar and the wall. Click "Close" in the box that appeared.

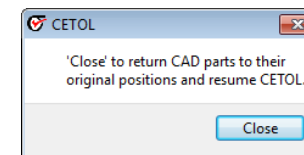
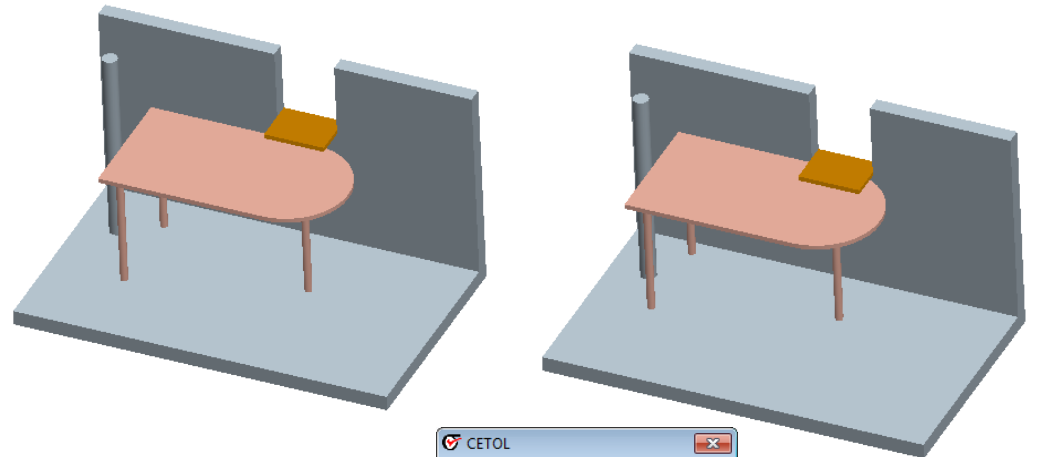
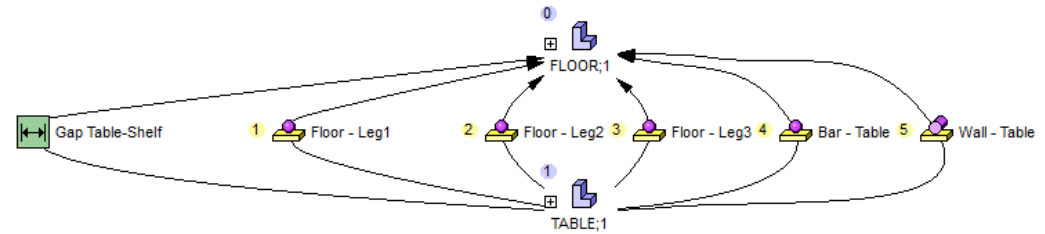



Notes

About features

CETOL is tightly integrated with ProE, and when modeling in CETOL, the “functional surfaces” from the CAD-model is used. This means that each part in the CETOL model contains a number of features that are based on the CAD-model geometry. A CAD-model may have many surfaces, but only the ones that are of interest for the tolerance analysis should be included in the CETOL-model.

CETOL can use many different type of features, but the most common ones are: flat surfaces, cylindrical surfaces, edges/lines and vertices.



Notes

Manage features

1. In the Tree view, expand the parts "FLOOR" and "TABLE".

We will manage and add all functional surfaces to the model before we define the variation.

2. Rename the features in the tree to the names shown in the figure. Click on each feature to verify that it is the right one.

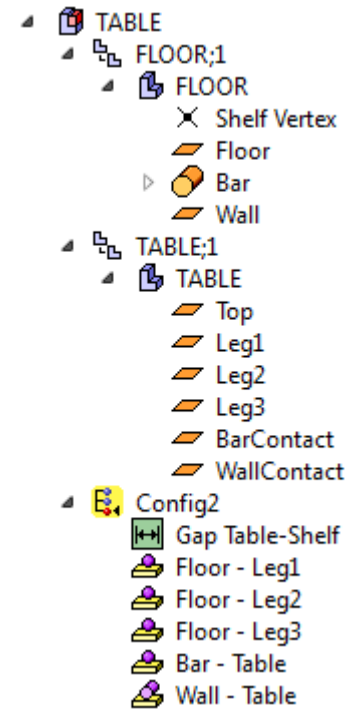



Notes

Add feature to the Table

1. Look at the drawing in the figure and think of what surfaces need to be included in the analysis. These surfaces are called “functional surfaces”, and are basically the surfaces (or features like vertex and edge) that we would like to add variation to, or the surfaces used by the joints.
2. Later in this tutorial we will add variation to the length of the legs, and to the thickness of the table top. In order to do so, we need to add the down side (see figure) of the table top as a feature, since it is needed in the dimensioning scheme.
3. Click on  in CETOL to add a Feature. Click on the down side of the table top (see figure), and then click middle mouse button to confirm.
4. Rename the new feature to "DownSide"

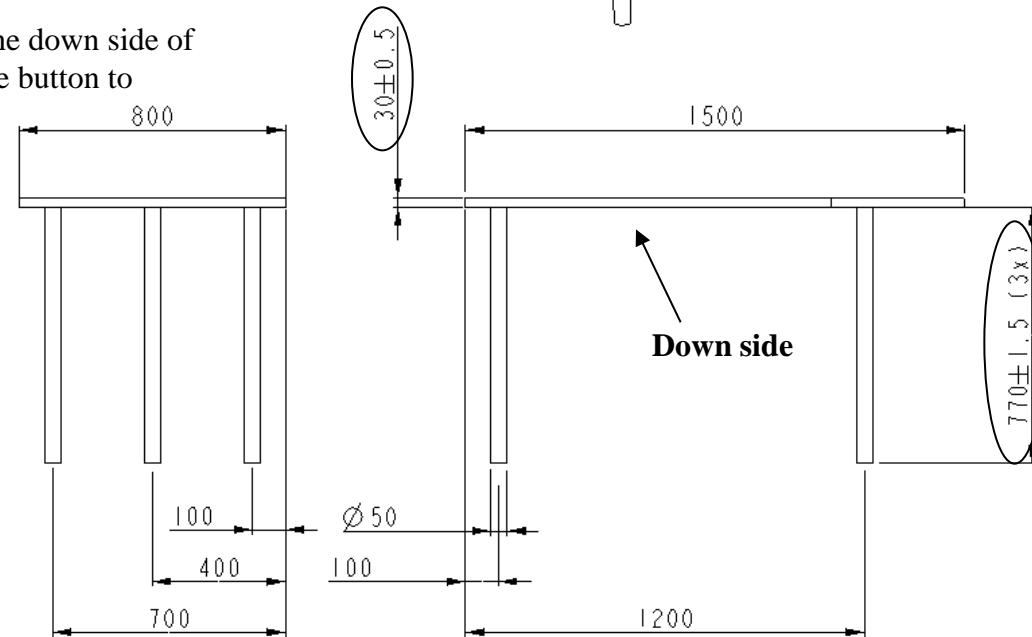
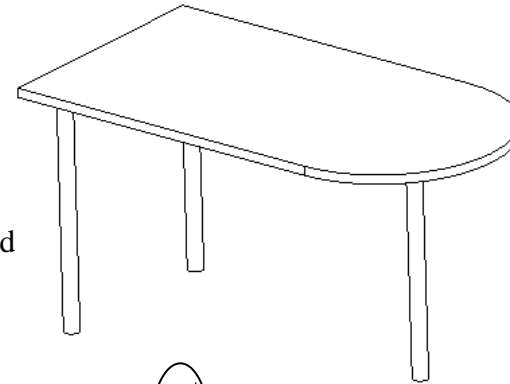



Notes

Add variation to the Table

1. Look at the drawing in the figure and think how the dimensioning scheme should look like.

It is possible to model a lot of variation for this part, but the person modeling should use the engineering judgment and focus on only the relevant variations. In this case that means to define variation between the top surface of the table and the down side, and also from the down side to the end surfaces of the legs.

2. The dimensioning scheme in CETOL should be built in the same way as the variation is “built” in to the product while producing it (i.e. based on manufacturing and assembly order, etc)
3. Before adding actual the variation. Drag and drop the “DownSide”-feature in the tree according to the figure. This is not crucial, but having a logical topological order in the tree, makes the modeling easier...

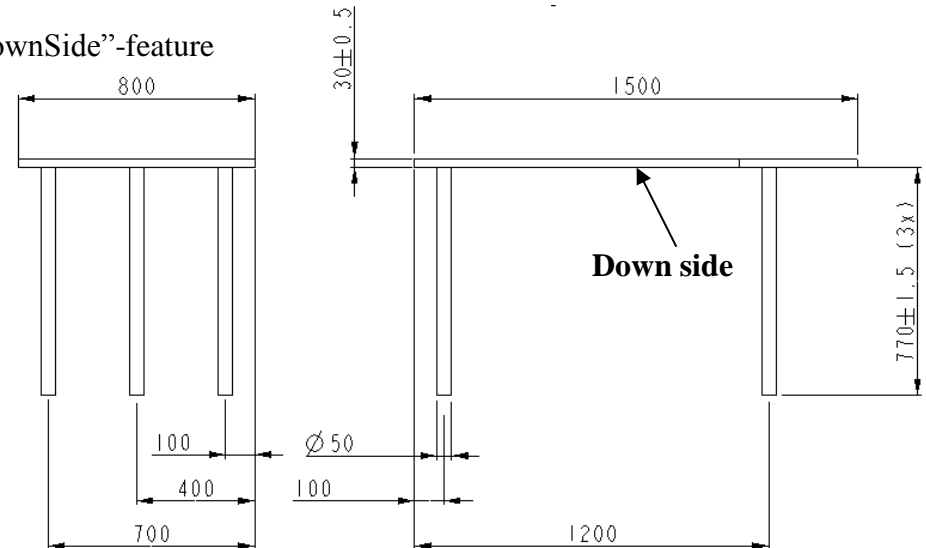
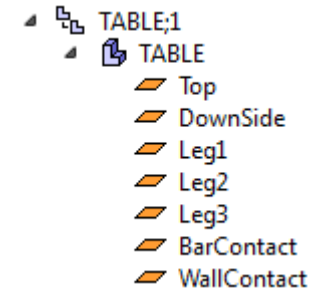



Notes

Add variation to the Table

4. First, add variation between the feature "Top" and the feature "DownSide":

Right click on the "DownSide" feature, select "Constrain Feature(s)". Select the "Top" feature and then click OK.

An offset variation is now created for the "DownSide" feature relative to the "Top" feature.

In the Graph view, Expand the part "Table" to see the new variation. It can also be seen in the Tree view under (expand) the "DownSide" feature.

5. Select the new variation \leftrightarrow to Top in the Tree and look in ProE to verify that it is defined on the correct surfaces.
6. In the Properties view, click on the "Tol/Rule" tab, and the change the tolerance to $\pm 0,5$.
7. Expand the \leftrightarrow to Top and select \leftrightarrow TY . In the Properties view, click on the "Distribution" tab to view the normal distribution for the variation, based on the tolerance (and in this case a Cpk-value of 1.0, which represents the quality in manufacturing of the part)

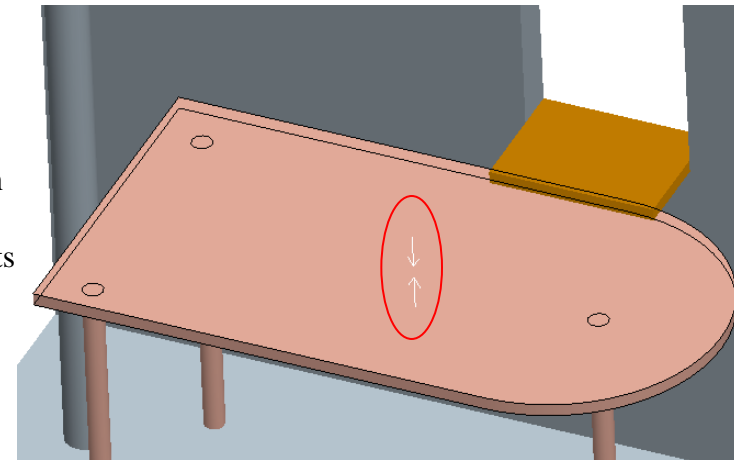
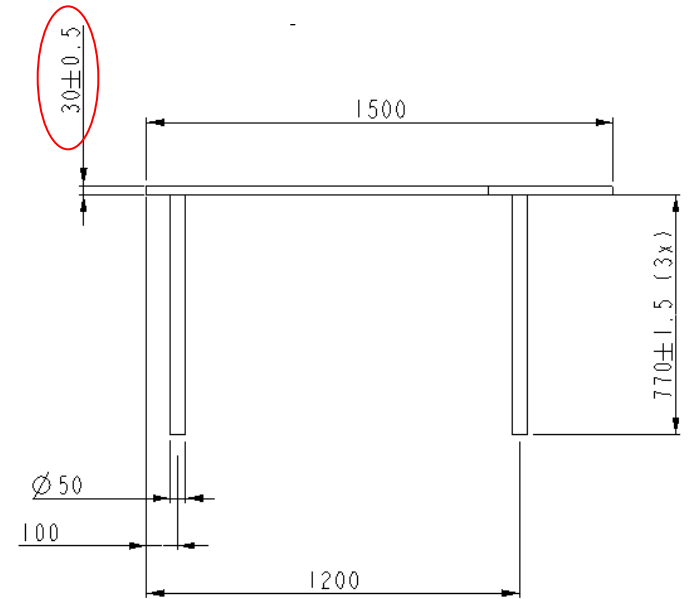
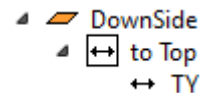



Notes

Add variation to the Table

8. Add variation between the leg features and the "DownSide":

Hold Ctrl and select features Leg1, Leg2 and Leg3. Right click and select "Constrain Feature(s). Select the "DownSide" feature and then click OK.

Three offset variations are now created for the leg features relative to the "DownSide" feature.

5. Select the three new variations( to DownSide) in the tree (one at the time. Expand leg features to see them) and look in ProE to verify that it is defined on the right surfaces.
6. In the Properties view, click on the "Tol/Rule" tab, and the change the tolerance to $\pm 1,5$ for all three legs.

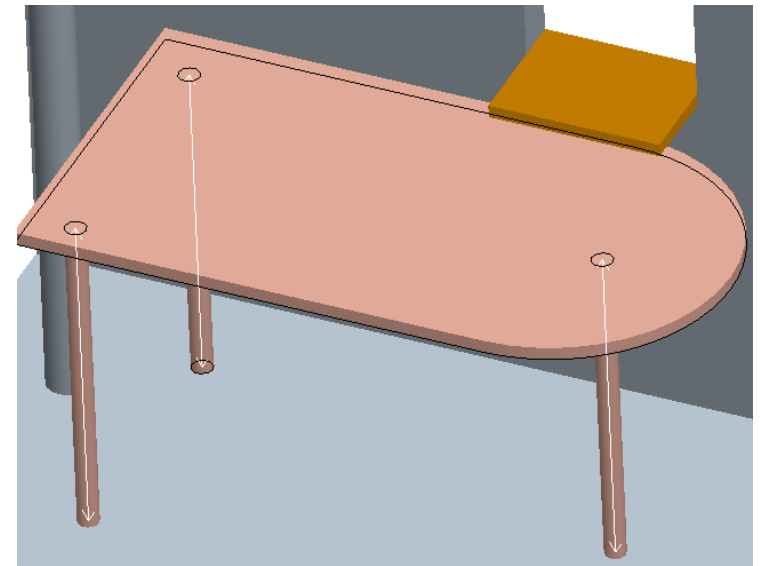
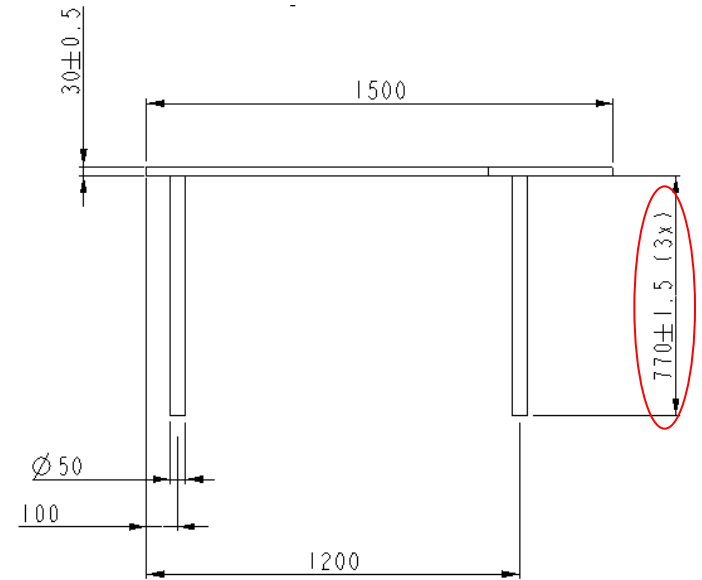



Notes

Add variation to the Floor (floor to shelf)

1. Look at the drawing in the figure and think how the dimension scheme should be done between shelf (corner) and floor.

There is often a more logical way to model variation. In this case it would probably “feel” better to define the variation of the shelf relative to the floor, than define it the other way around.

2. In the Tree view, drag and drop the “Shelf Vertex” to be last feature in FLOOR (upper figure)
3. In the Tree view, right click on the “Shelf Vertex” feature, select “Constrain Feature(s)”. Select the “Floor” feature and then click OK.

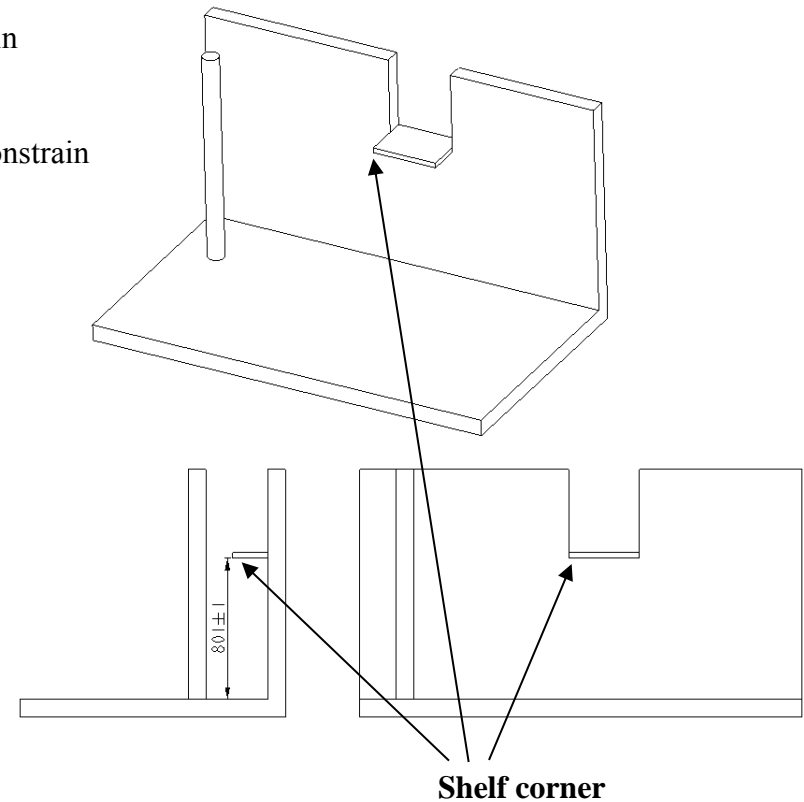
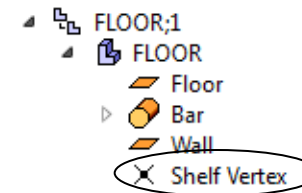



Notes

Add variation to the Floor (floor to shelf)

4. Select the new variation (“to Floor” in the figure) and look in ProE to verify that it is defined from the floor to the shelf corner.
5. In the Properties view, click on the ”Tol/Rule” tab, and the change the tolerance to $\pm 1,0$.

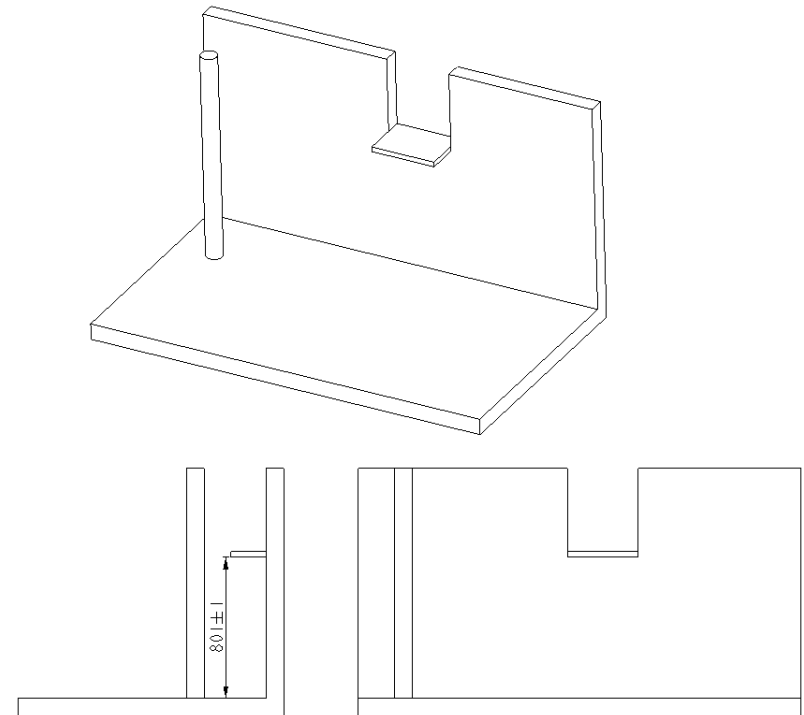
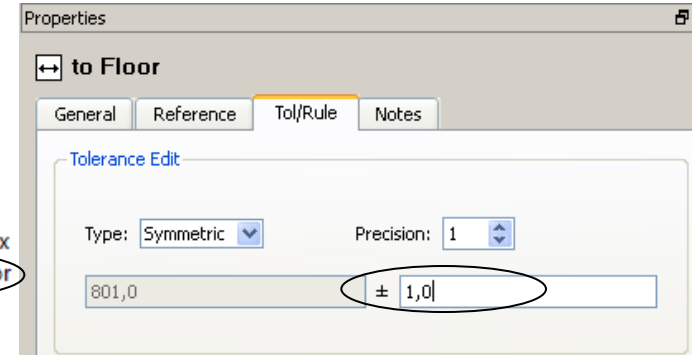
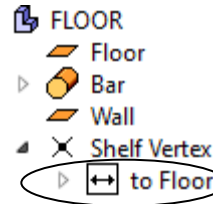



Notes

Verify Table sensitivities

1. In the Tree view, expand according to the figure, in order see the “TY” variations (length of the Table legs)
2. Verify the sensitivities of the legs by visualize the behavior (animate) of varying one length at the time. Select the “TY” for Leg 1 and click on . Change the “Scale Factor” to 30 (exaggerate for visualization). Click on “Recalculate” and “Start animation”.
3. Study the behavior of the Leg1 variation in ProE. The white arrow shows the varied dimension, and the green arrow the measure between the table top and the shelf corner.
4. In the Visualize Sensitivities dialogue box, notice that the sensitivity is roughly 0,7. This means that by increasing the length of the leg by 1 unit, the measure will be affected by a factor of 0,7.
5. Click ”Stop Animation” and click Variable (at the top of the dialogue box). Then select the “TY” of Leg2. Click OK.
6. In the same way for Leg 2 and 3, change “Scale Factor”, “Recalculate”, “Start Animation” and look at the sensitivity for the two remaining legs. Close the dialogue box.

Does the sensitivities make sense? (The sensitivity of the shelf corner and table thickness is 1.0, and will not be investigated further)

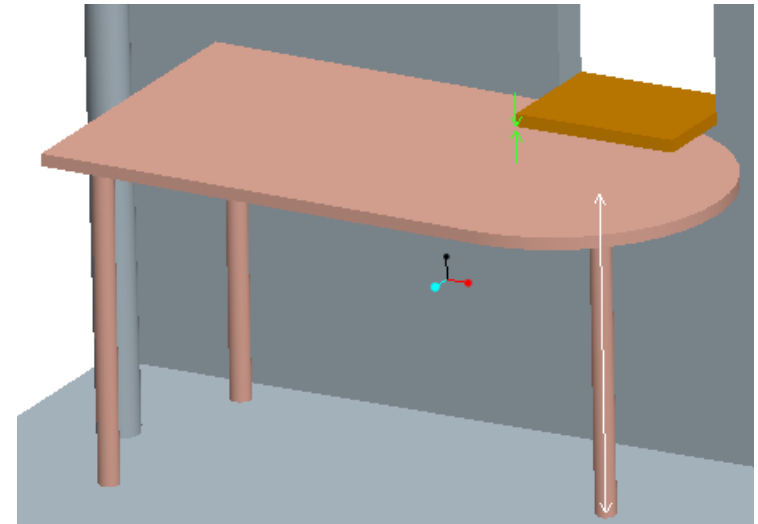
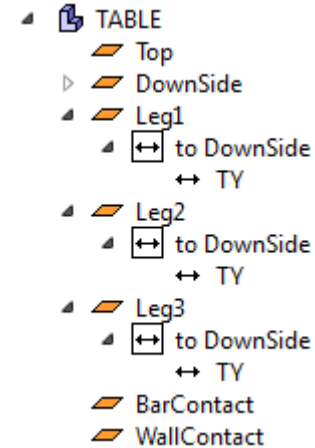



Notes

Results

1. The model is now complete and it is time to run the analysis by clicking on . Then click on OK to run a 1st-Order Approximation.
2. To review the results, select measure "Gap Table-Shelf" and then click on the "Variation" tab in the Properties view.
3. The variation of the measure is shown in the figure. The curve shows the statistical distribution of the results, where the blue area (96%) shows that chance of the table fitting under the shelf, and the red area (4%) the chance of not fitting.
4. The rectangle is representing the worst case scenario. It shows that if all tolerances are on their worst position in the tolerance range, there would be an interference of 2,55 mm between the table top and the shelf.
5. Think for a second about the statistical approach vs. the worst case approach, and the meaning of 4% chance of not fitting vs. an interference of 2,55 mm.
6. Notice that the mean value of the curve is 1 mm (gap), just like the for nominal CAD-value. In this case there are no external forces or non-symmetrical tolerances, which sometimes cause more "out of specification products" than the actual variation (width of the curve) itself...

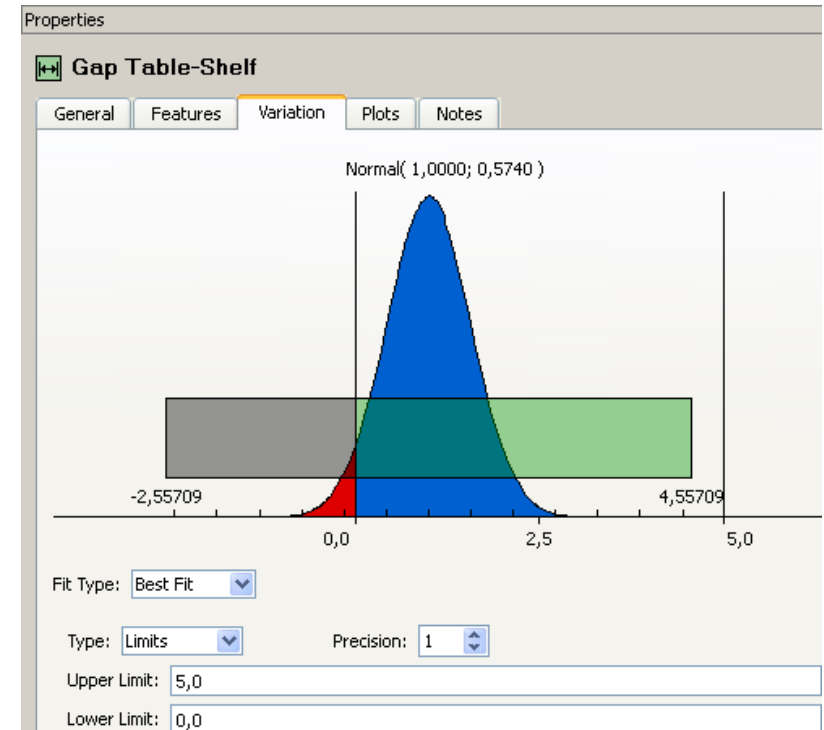



Notes

Results - Sensitivities

1. To review the sensitivities, click on the “Plots” tab, and the “Sensitivities” sub-tab. The figure shows the sensitivities of all variations in the model. It is important to verify that your model is correct by controlling the sensitivities. They should make sense!
2. The first two sensitivities in the figure has a value of 1. That make sense, since the variation of the height of the shelf corner, or the variation of the table top thickness, should affect the measure with a ratio of 1 to 1.

The sensitivities for the Leg1, Leg2 and Leg3 have the same sensitivities as when we animated their sensitivities. The measure (table to shelf gap) will be most affected by varying the length of Leg1, a bit less by varying the length of Leg3, and not so much by Leg 2.

The diameter of the bar has a sensitivity of 0. That also make sense. Varying it will only move the table sideways.

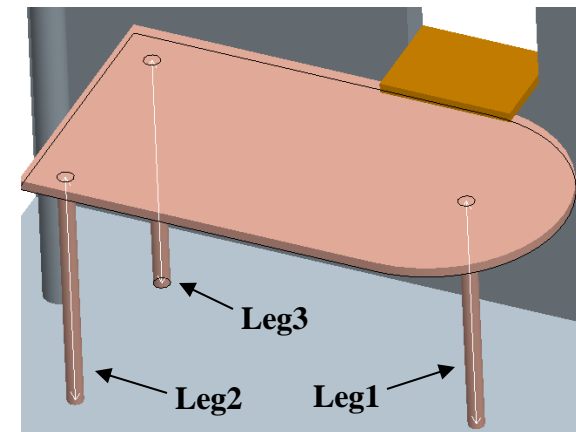
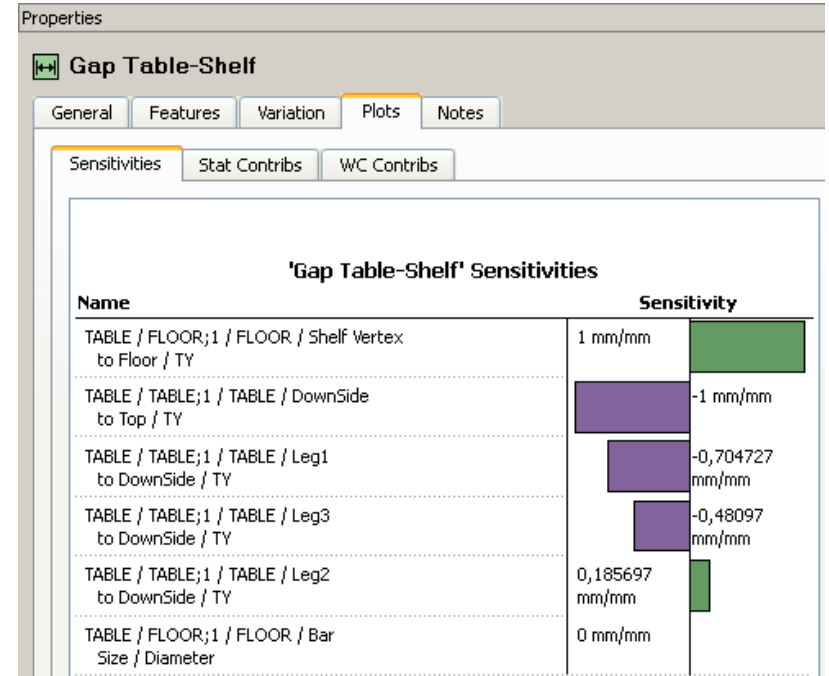



Notes

Results - Contributions

1. To review the contributions of each varied dimension and its tolerance, click on the “Stat Contribs” (Statistical Contributions) sub-tab. The figure shows the contributions of all variations in the model. The largest contributions are not always the ones you would have expected, but it is important to review them and see if they make sense, and that you understand why! The sensitivities on the previous page is only about geometrical ratios. The contributions is a product of sensitivities and tolerances.
2. The figure shows all contributions in the model. The largest contribution to the measure (table to shelf gap), with 37,68% of the total variation, is the variation of Leg1. The second largest contribution is the height of the shelf corner, with 33,72%. Etc...
3. To minimize the risk of having a table not fitting under the shelf, one should focus on the top two contributions. Tightening tolerances (reducing variation) on the table top thickness (8,43%) or the length of Leg2 (2,62%) would not have any major effects on the total variation.

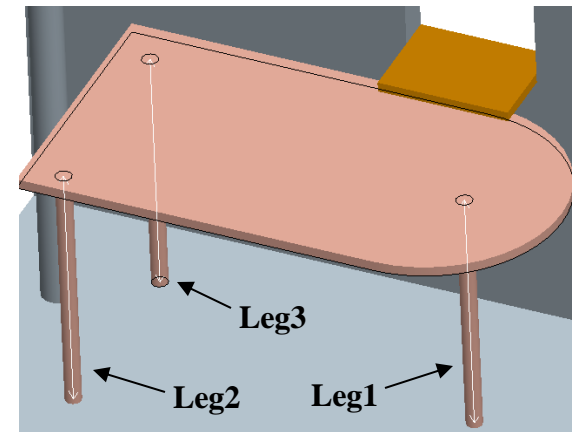
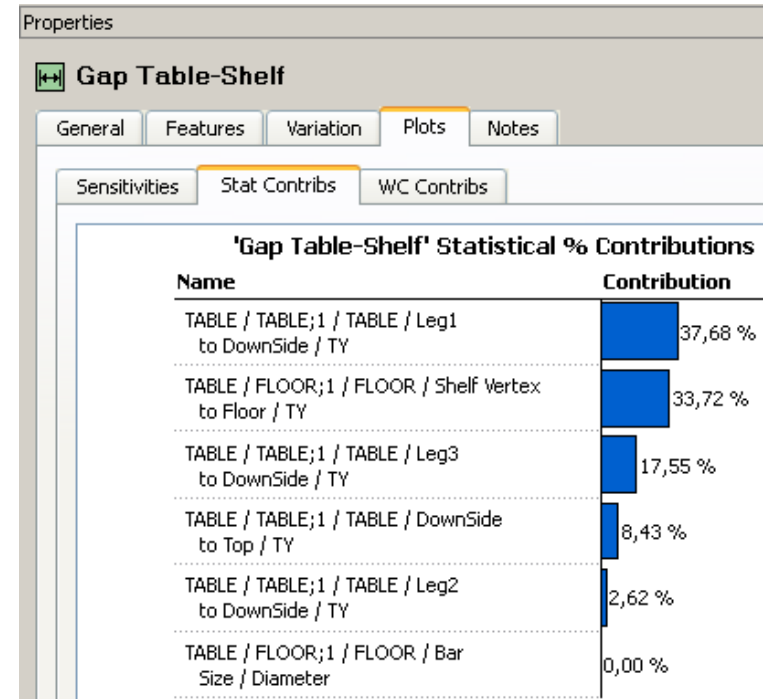



Notes

Results – Tolerance optimization

1. The part of CETOL used so far is called "Modeler". There is a second part called "Analyzer", which is used for analyzing and optimizing tolerances/Variation.
2. Click on  (at the top menu) to open the Analyzer window.
3. In the bottom left part which handles the measure "Gap Table-Shelf", click on the "Variation" tab. The same variation that we just looked at in the modeler is displayed.
4. Click on "Variance Contrib" until the biggest contributors will be displayed.

Name	Context	Nominal	Tolerance	Cpk	Sensitivity	Variance Contrib	Shift Contrib
to DownSide	TABLE1/Leg1	770	770.0 ±1.5	1.00	37.68 %	46.46 %	
to Floor	FLOOR1/Shelf Vertex	801	801.0 ±1.0	1.00	33.72 %	0.00 %	
to DownSide	TABLE1/Leg3	770	770.0 ±1.5	1.00	17.55 %	0.00 %	
to Top	TABLE1/DownSide	30	30.0 ±0.5	1.00	8.43 %	53.54 %	
to DownSide	TABLE1/Lea2	770	770.0 ±1.5	1.00	2.62 %	0.00 %	

The screenshot shows the 'Results List' and 'Variance Contrib List' for the 'Gap Table-Shelf' measure. The 'Results List' shows a nominal value of 1 and a tolerance of 5.0/0.0. The 'Variance Contrib List' shows the following data:

Name	Context	Nominal	Tolerance	Cpk	Sensitivity	Variance Contrib	Shift Contrib
Size	FLOOR1/Bar	101.6	101.60 ±0.05	1.00	0.00 %	0.00 %	
to Floor	FLOOR1/Shelf Vertex	801	801.0 ±1.0	1.00	33.72 %	0.00 %	
to Top	TABLE1/DownSide	30	30.0 ±0.5	1.00	8.43 %	53.54 %	
to DownSide	TABLE1/Leg1	770	770.0 ±1.5	1.00	37.68 %	46.46 %	
to DownSide	TABLE1/Lea2	770	770.0 ±1.5	1.00	2.62 %	0.00 %	

The 'Gap Table-Shelf' properties are shown below, including a 'Variation' tab with a normal distribution plot.

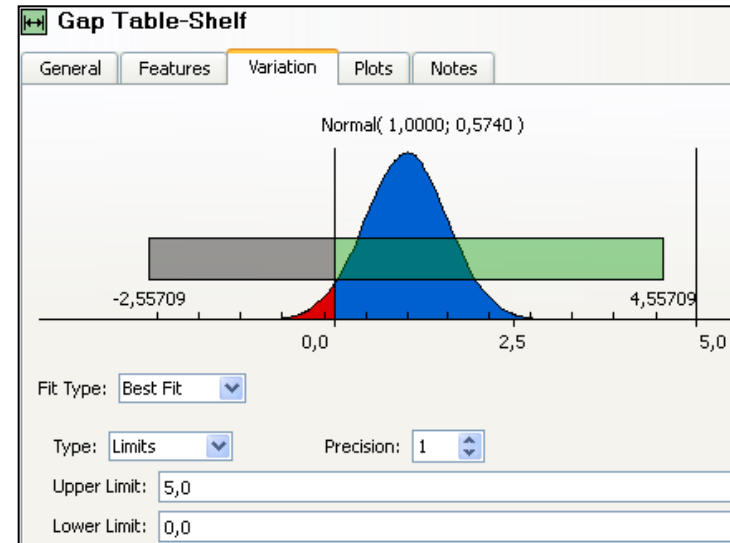

Results – Tolerance optimization

Notes

1. Click on  to DownSide (the biggest contributor) to select it, and then click on the "Tol/Rule" tab (at the lower part on the right hand side of the screen). The upper figure shows the tolerance of Leg 1. Change it to **0,5** and click Enter on your keyboard (to execute the change).
2. Cetol uses an analytical analysis solution, which means that it is possible to change tolerances and instantly see the effect it has on the model and variation. By looking in the lower left view and clicking undo (and then redo), it is possible to see the effect of the changed tolerance on the total variation.
3. The "Yield" column at the top shows that tightened tolerance makes it go from 0,959 to 0,984 (undo/redo). In other words, from 4,1% chance of not fitting to 1,7%.
4. The changed tolerance is just an example of how to optimize the tolerances. The purpose of tolerance optimization is to optimize performance, robustness and production cost. A common strategy is to loosen tolerances for the dimensions that does not affect much, and thereby saving money that could be spent on tighten the tolerances that really matters.
5. (In a case like this, it is also common to adjust nominal values to make it fit, instead of changing tolerances, or do both. A nominal change of the table legs would not tighten the curve, just move it sideways.)

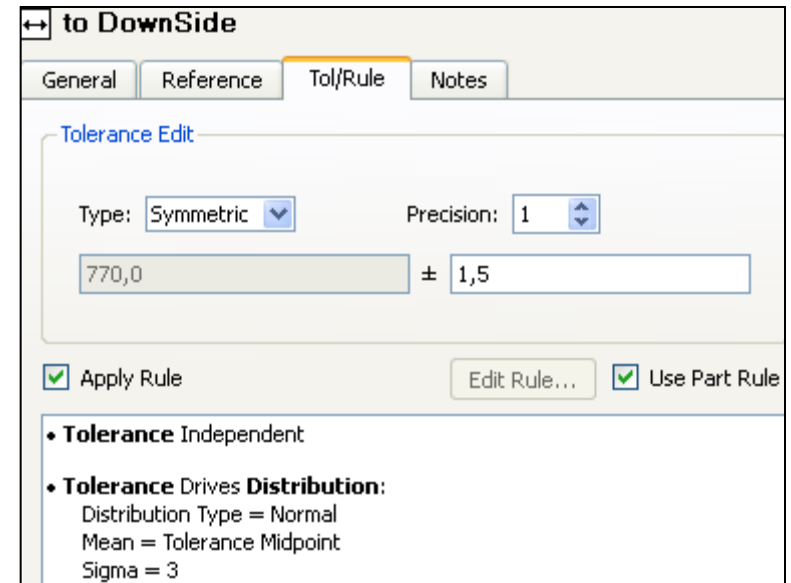

to DownSide

General Reference Tol/Rule Notes

Tolerance Edit

Type: Symmetric Precision: 1

770,0 ± 1,5

Apply Rule Edit Rule... Use Part Rule

- Tolerance Independent
- Tolerance Drives Distribution:
Distribution Type = Normal
Mean = Tolerance Midpoint
Sigma = 3

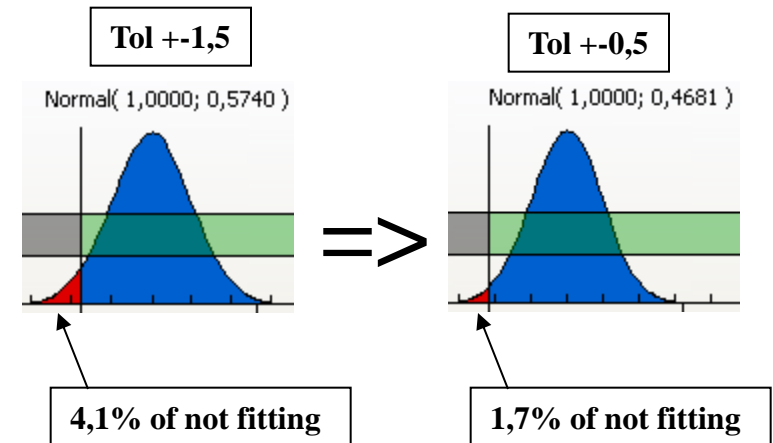



Notes

Summary

This hands-on exercise shows how to work with CETOL, and how to simulate variation on your ProE designs.

The purpose of optimizing the variation is to improve performance, robustness, quality and production cost. CETOL is an excellent tool to use, to achieve this!

This ends the tutorial. Feel free to change more tolerances and see the effect on the total variation. Notice that the percentage for the contributions are changing (“Plot” tab - and “StatContribs” or “WC Contribs” (worst case) sub-tabs)